

新工艺

新技术

新品质



長江機械  
CHEUNG KONG MACHINERY



CONTACT US  
联系我们

东莞市骏兴机械科技有限公司  
DONG GUAN CHUN HING MECHANICAL TECHNOLOGY CO.,LTD

官网 Website: [www.chm-hk.com](http://www.chm-hk.com)  
邮箱 E-mail: [chm015@szchm.com](mailto:chm015@szchm.com) / [luolily2019@163.com](mailto:luolily2019@163.com)  
电话 Tel: +86 137 1386 1632 (WhatsApp)  
地址: 东莞市桥头镇桥新一路桥泰街2号  
Address: No.2 Qiaotai Road, West Road of Qiaoxin, Qiaotou Town, Dongguan City, Guangdong Province, China.



WEBSITE



Youtube



怀匠心 践匠行 做匠人

一站式纸张分切解决方案提供商  
Professional Paper Sheeter Supplier



WhatsApp

## 企业简介 Introduction

长江机械是专业的卷筒纸分切机制造商，是国内为纸制品加工提供方案的专业提供商。自2004年创业以来，长江机械坚持以用户为中心的创新体系驱动企业持续健康发展。目前成为卷筒纸分切机行业的产能龙头。

技术创新是行业的翘楚，是同行业专利技术最多的企业，被誉为推动切纸机技术更新换代的一根标杆；雄厚的技术创新底蕴，培养出大量的专业人才，有着全行业最专业的生产技术和售后服务团队，受到国内外广大客户好评。

今天的“CHM”已经成为民族品牌的代表而走向世界，成为中国制造的又一面旗帜。

CHM, Cheung Kong Machinery (HK) Co., Ltd., the professional sheeting machine manufacturer and the leading paper sheeting solution provider in China.

Since 2004, established in Hong Kong, CHM group keeps forwarding with the idea of insists on a client-centric and innovation. CHM has become the leader of the paper sheeting machinery producer in China.

Owns the highest number of patent in the industrial. We are well-known as the "standard setter". With our solid technological capabilities, we have nurtured numerous professionals in the field. And now having the highest production capabilities in China. Moreover, the international standard after-sales technical team providing state-of-the-art services to our clients, receiving all-rounded recognitions among our Chinese and global clientele.

Nowadays, CHM has become the flagship enterprise in the Chinese sheeting machinery industrial and expanding towards the international market.



## 荣誉证书 Honor



自主研发创新能力强，曾参与制定行业标准，所获专利逾110余项

Owns the best R&D team and highest number of patent, more than 110 item, as the participator of the industry standards.

## 我们的优势 Advantages

- 广东、山东、江苏三个工厂总面积接近14万平方米，成为全球第二大面积并拥有自主生产能力的分切机制造商；  
The three factories in Guangdong, Shandong and Jiangsu have a total area of nearly 140,000 square meters, becoming the world's second largest sheeting machine manufacturer with independent production capacity;
- 生产能力大，市场占有率广；  
Large production capacity and wide market share;
- 全国同行最专业，拥有自主研发、创新能力，是国家分切机标准的制定者——我们专业、专心、专一；  
The most professional counterparts in the country, with independent research and development, innovation ability, is the national Slitter standard setter - we are professional, dedicated, dedicated;
- 追求品质——永远奉行“质量第一，诚信为本”的宗旨  
Pursuing the quality of "honesty first" forever;
- 拥有专业的技术、售后服务团队；我们永远对设备进行“全生命周期服务”；对设备升级改造、维修保养、对纸品加工、印后加工、印刷行业周边设备提供解决方案，为不同品牌的设备提供优质服务。

We have a professional technical and after-sales service team; we always provide "whole life cycle service" for the equipment; we provide solutions for equipment upgrading, maintenance, paper processing, post press processing, printing industry peripheral equipment, and provide high-quality services for different brands of equipment.

## 东莞骏兴 DONG GUAN CHUN HING



- ① 公司俯瞰 CHM Aeroview
- ② 公司实景 CHM View
- ③ 生产基地 Production Base

## 山东长江 SHANDONG CHEUNG KONG



- ① 公司俯瞰 CHM Aeroview
- ② 公司实景 CHM View
- ③ 生产基地 Production Base

## 东台骏兴 DONGTAI JUNXING



- ① 公司俯瞰 CHM Aeroview
- ② 公司实景 CHM View
- ③ 生产基地 Production Base

# CHM-1100/1400/1700/1900

## 电脑高精密卷筒纸分切机 Precision High Speed Sheeter



可选配置：多油压纸架  
Optional : Can add more unwind station  
(cutting 4 rolls, 6 rolls, 8 rolls at the same time)



电脑高精密卷筒纸分切机, 广泛应用于卡纸、铜版纸、牛皮纸、文化纸、双胶纸、高光相纸、金银卡纸、铝箔纸、激光镭射纸、烟酒包装纸等, 是目前造纸业及印刷业中普遍采用的纸制品加工机械。

A servo-driven high speed, high precision and high efficiency sheeter. Capable on wide range of paper, board paper, art paper, kraft paper, etc... Widely used by printing, packaging and paper suppliers.



双臂油压无轴原纸架  
Hydraulic shaft-less unwind station



多点碟式刹车器  
Multi-disc brake



高精度单刀切纸机  
High precision single rotary sheet cutter



自动齐纸集纸设备  
Auto Jogger System



输送部  
Conveyor unit



电器操控系统  
Electric control system

### 技术指标 Technical indicators

CHM型号 CHM Type	CHM-1100	CHM-1400	CHM-1700	CHM-1900
切纸型式 Cutting Way	上刀回切, 下刀固定 Top blade rotary, bottom blade fixed			
纸张适用范围 Refence weight of cutting paper	60-550GSM	60-550GSM	60-550GSM	60-550GSM
切纸精度 Cutting accuracy	±0.5mm	±0.5mm	±0.5mm	±0.5mm
最高切断速度 Max cutting speed	300刀/分钟 300sheets/min	300刀/分钟 300sheets/min	300刀/分钟 300sheets/min	300刀/分钟 300sheets/min
最高切断米速 Max.cutting meter speed	300米/分钟 300m/min	300米/分钟 300m/min	300米/分钟 300m/min	300米/分钟 300m/min
切断长度范围 Cutting length range	450-1100mm	450-1650mm	450-1650mm	450-1650mm
最大卷筒纸直径 Max scroll diameter	1500mm	1800mm	1800mm	1800mm
收纸台堆纸高度 Stacking height Of paperboard	含托盘1000mm(39") (Include Pallet height)	含托盘1500mm(59") (Include Pallet height)	含托盘1500mm(59") (Include Pallet height)	含托盘1500mm(59") (Include Pallet height)
最大切纸宽度 Max.paper-cutting width	1100mm	1400mm	1700mm	1900mm
总重量 Weight	10000kg	12000kg	13000kg	14000kg
尺寸(长*宽*高) Dimension(LxWxH)	12203mm*3553mm*2030mm	12518mm*3853mm*2230mm	12518mm*4153mm*2230mm	12518mm*4353mm*2230mm

实时数字控制  
Real-time digital control

生产记录功能  
Production record function

免压纸轮装置  
No paper roller required

与企业ERP系统相连  
Connected with the enterprise ERP system

## CHM Custom Machine 定制机型

### L型高低纸架卷筒纸分切机

### L-Type Up And Low Paper Roll To Sheet Cutting Machine



L型高低纸架  
L-Type Up And Low Paper Roll

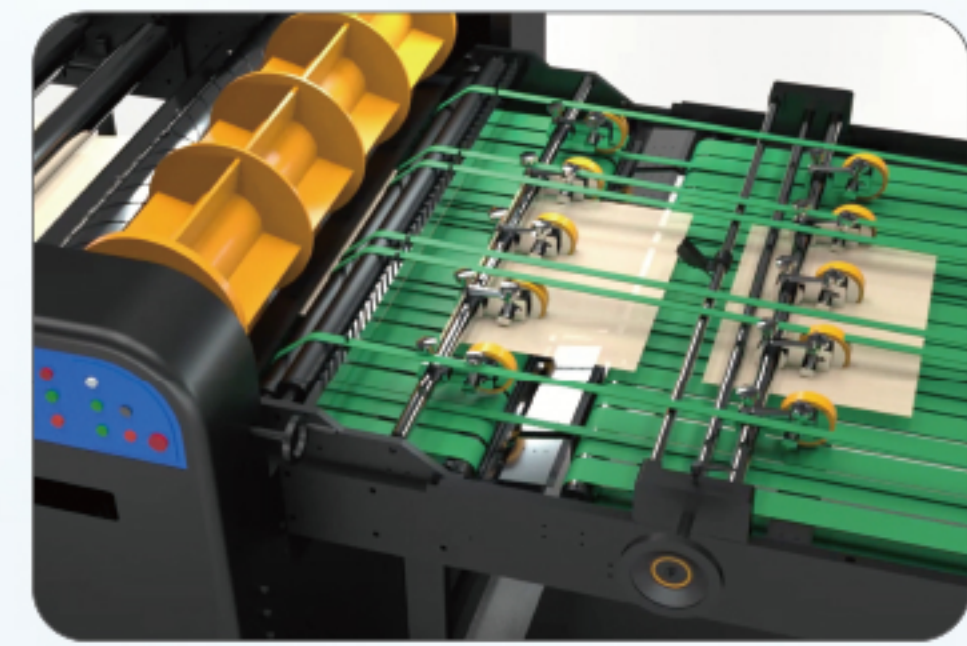

高精度单刀切纸机  
High precision single rotary sheet cutter



自动齐纸集纸设备  
Auto Jogger System



这款高低纸架卷筒纸分切机适合分切28克至60克之间的纸张，比如我们薄如羽翼的圣经纸、离型纸和食用硅油纸等，并且可实现多卷同时分切，最多可达12卷，切纸速度平稳，损耗低、效率高！

This is L-Type Up And Low Paper Roll To Sheet Cutting Machine is suitable for cutting 28g to 60g Paper between grams, such as our thin Bible paper and release paper that are as thin as wings And it can be used with edible silicone oil paper, and can paper roll to sheet cutting machine paper roll sheeting machine, up to a maximum of up to 12 rolls, stable paper cutting speed, low loss, and high efficiency!

# CHM-SGT1400/1700/1900

## 高精度双回旋刀卷筒纸分切机

### High Precision Synchronize-fly Sheeter



工作原理  
Working Principle

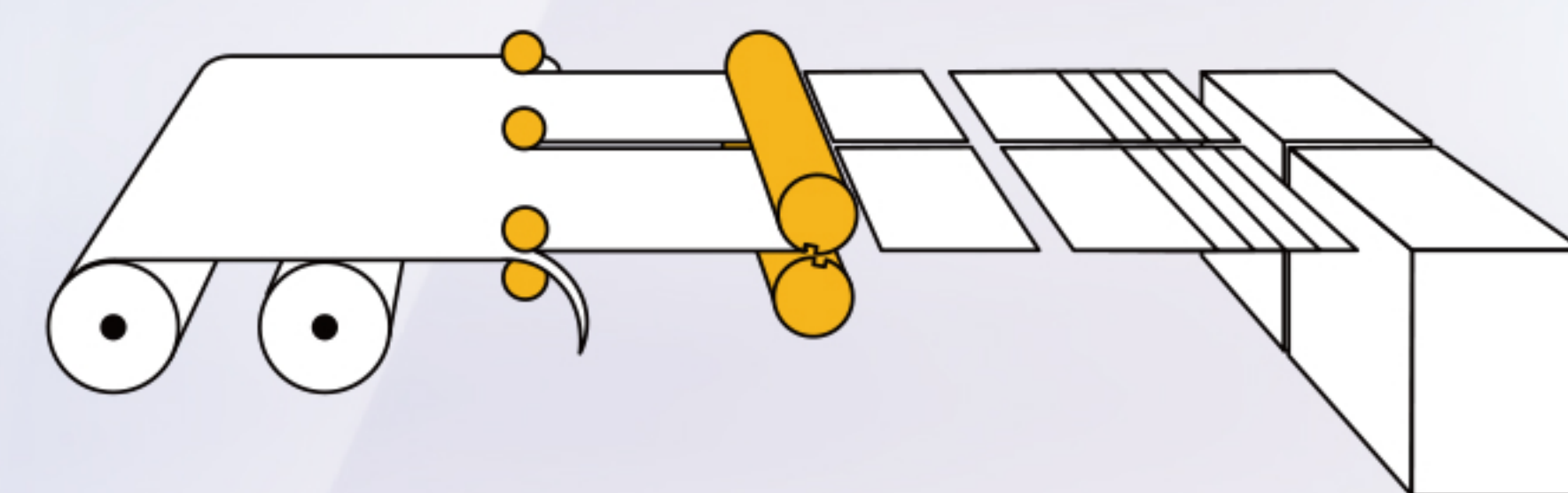

CHM-SGT1400/1700/1900高精度双回旋刀卷筒纸分切机是以上下刀对偶螺旋线分切形式剪切，切口干净、整齐、分切精度高等特点，广泛适用于卡纸、铜版纸、牛皮纸、文化纸、双胶纸、高光相纸、金银卡纸、铝箔纸、激光镭射纸、烟酒包装纸等。

CHM-SGT1400/1700/1900 High Precision Synchronize-fly Sheeter features fibre-less and clean cuts with high dimensional precisions. Best for board paper, art paper, kraft paper and packing paper or board etc.

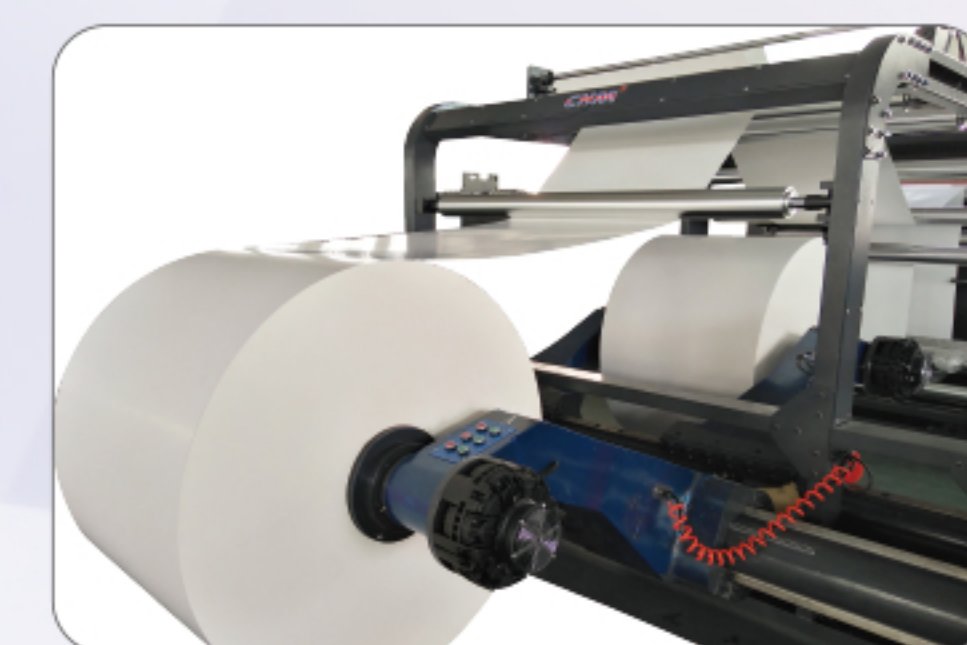

双臂液压无轴原纸架  
Hydraulic shaft-less unwind station



自动导边系统  
Auto web guide system



电动小反曲控制系统  
Electric de-curl unit



高精度双回旋横切刀组  
High precision synchronic-fly cutting unit



自动齐纸集纸设备  
Auto Jogger System

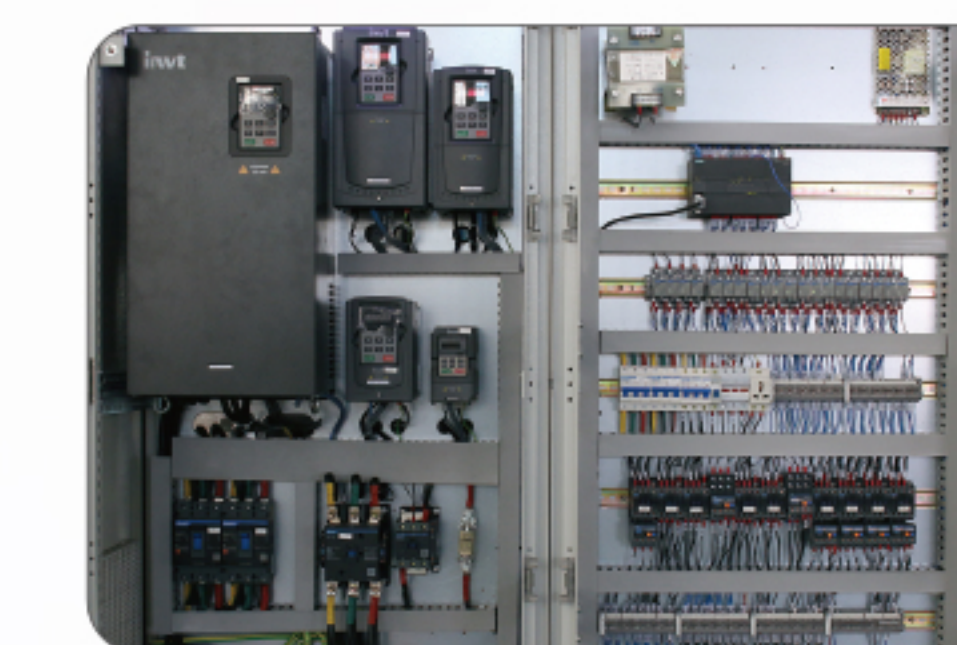

电器操控系统  
Electric control system



可选配置：“喷码+检测+分切”  
Optional Configuration: Inkjet+Detection+Slitting

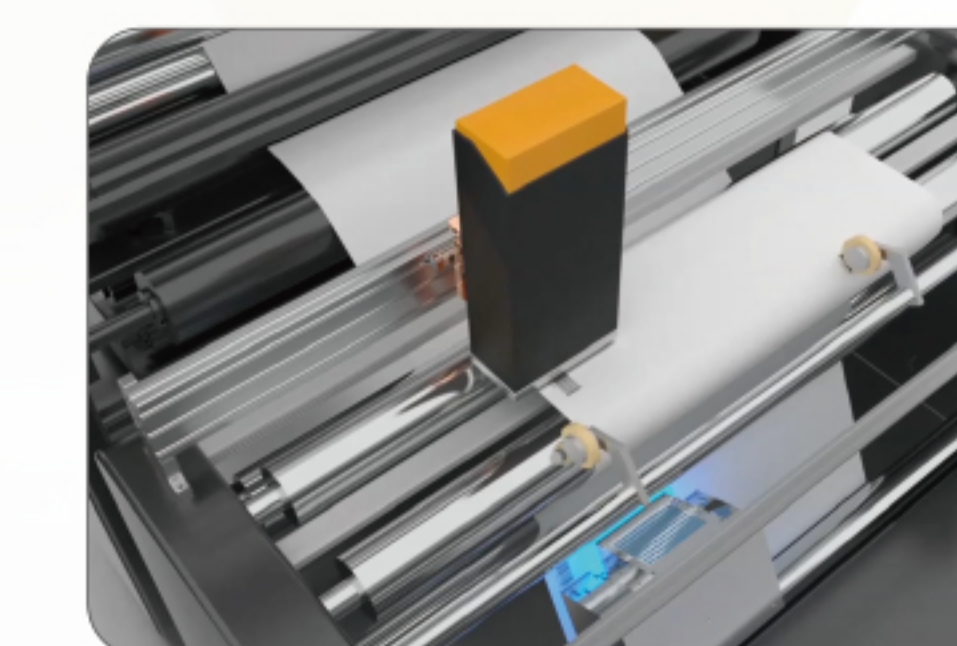

喷码系统 (爱普生喷头)  
Ink jet system (Epson nozzle)



切完直接上印刷机  
After cutting, it can be directly printed on the printing machine

#### 技术指标 Technical indicators

CHM型号 CHM Type	CHM-SGT1400	CHM-SGT1700	CHM-SGT1900
切纸型式 Cutting way	上下刀回旋切 Upper and lower rotary cutting mechanism		
纸张适用范围 Refence weight of cutting paper	200-1000GSM	200-1000GSM	200-1000GSM
切纸精度 Cutting accuracy	±0.5mm	±0.5mm	±0.5mm
最高切断速度 Max cutting speed	300刀/分钟 300sheets/min	300刀/分钟 300sheets/min	300刀/分钟 300sheets/min
最高切断米速 Max.cutting meter speed	300米/分钟 300m/min	300米/分钟 300m/min	300米/分钟 300m/min
切断长度范围 Cutting length range	450-1650mm	450-1650mm	450-1650mm
最大卷筒纸直径 Max scroll diameter	1800mm	1800mm	1800mm
收纸台堆纸高度 Stacking height Of paperboard	含托盘1500mm (Include Pallet height)	含托盘1500mm (Include Pallet height)	含托盘1500mm (Include Pallet height)
最大切纸宽度 Max.paper-cutting width	1400mm	1700mm	1900mm
总重量 Weight	15000kg	17000kg	18400kg
尺寸(长*宽*高) Dimension(LxWxH)	14453mm*4675mm*2350mm	14453mm*4975mm*2350mm	14453mm*5175mm*2350mm

# CHM-SGT1400H/1700H

## 高精度双回旋刀卷筒纸分切机 High Precision Synchronize-fly Sheeter



工作原理  
Working Principle

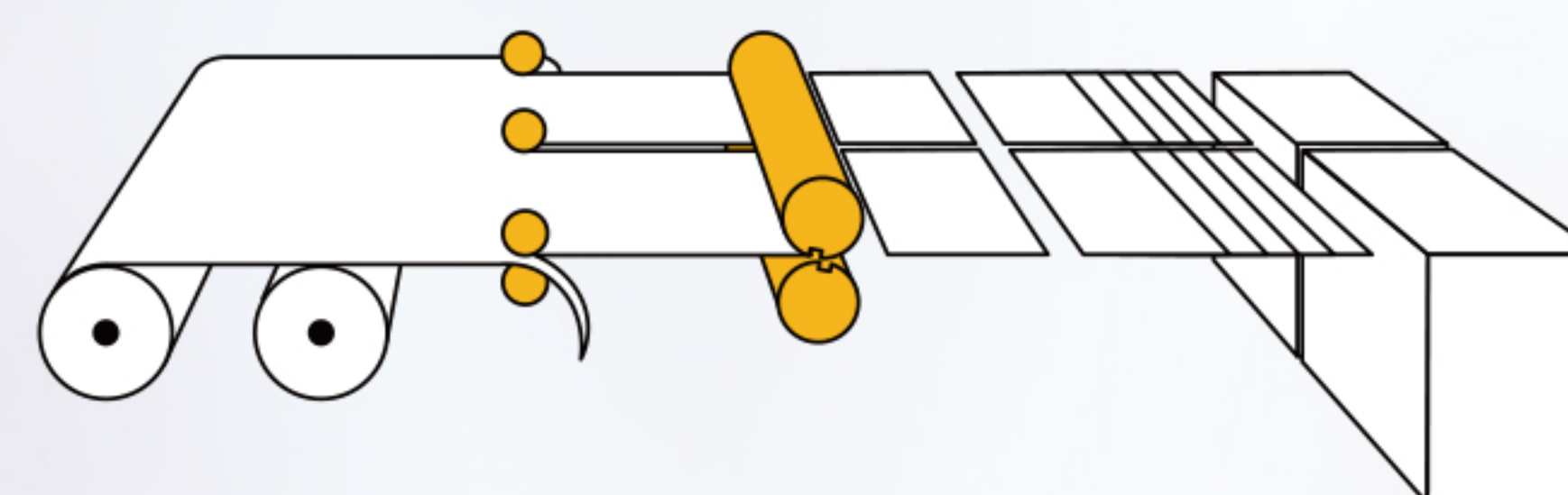

CHM-SGT1400H/1700H高精度双回旋刀卷筒纸分切机是以上下刀对偶螺旋线分切形式剪切，切口干净、整齐、分切精度高等特点，广泛适用于卡纸、铜版纸、牛皮纸、文化纸、双胶纸、高光相纸、金银卡纸、铝箔纸、激光镭射纸、烟酒包装纸等。

CHM-SGT1400H/1700H High Precision Synchronize-fly Sheeter features fibre-less and clean cuts with high dimensional precisions. Best for board paper, art paper, kraft paper and packing paper or board etc.



双臂油压无轴原纸架  
Hydraulic shaft-less unwind station



自动导边系统  
Auto web guide system

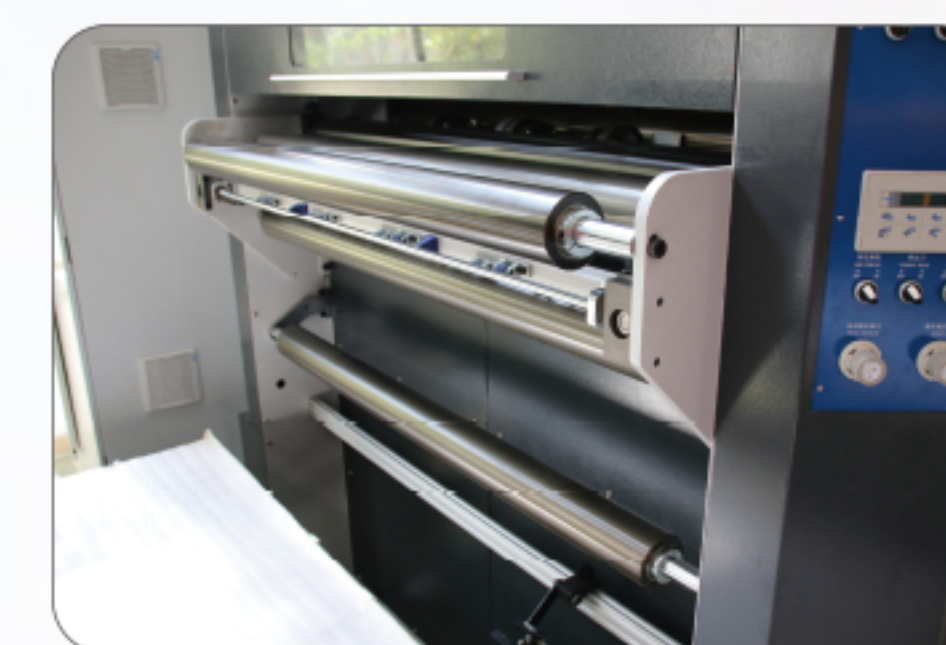

电动小反曲控制系统  
Electric de-curl unit



自动定位分条刀  
Automatic position slitting system



高精度双回旋横切刀组  
High precision synchronic-fly cutting unit



输送部  
Conveyor unit

### 技术指标 Technical indicators

CHM型号 CHM Type	CHM-SGT1400H	CHM-SGT1700H
切纸型式 Cutting way	上下刀回旋切 Upper and lower rotary cutting mechanism	
纸张适用范围 Reference weight of cutting paper	150-1000 GSM	150-1000 GSM
切纸精度 Cutting accuracy	±0.3mm	±0.3mm
最高切断速度 Max cutting speed	300m/min	300m/min
最大裁切刀数 Max.number of cutting knives	400cuts/min	400cuts/min
切断长度范围 Cutting length range	400-1700mm	400-1700mm
最大卷筒纸直径 Max scroll diameter	Max1800mm (71")	Max1800mm(71")
收纸台堆纸高度 Stacking height Of paperboard	含托盘1600mm (Include Pallet height)	含托盘1700mm (Include Pallet height)
最大切纸宽度 Max.paper-cutting width	Max1500mm (59")	Max1700mm(66.9")
总重量 Weight	21000kg	24000kg
尺寸(长*宽*高) Dimension(LxWxH)	15046mm*5193mm*2485.5mm	14808mm*7035mm*2450mm

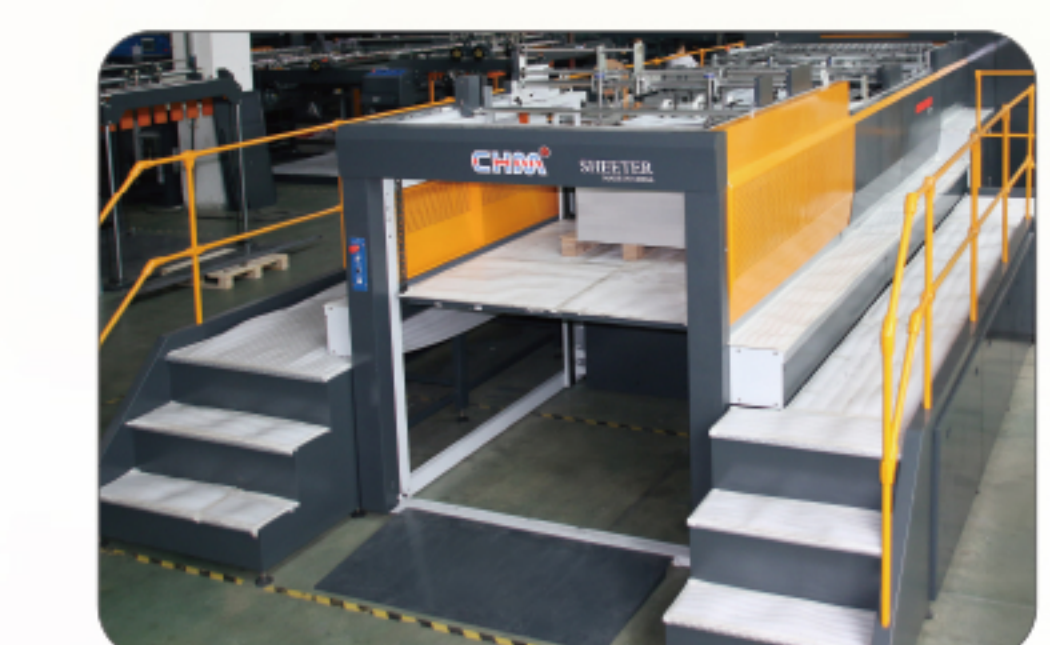

自动齐纸集纸设备  
Auto Jogger System

# CHM-SGT1400T (Tiger)

## 高精度双回旋刀卷筒纸分切机 High Precision Synchronize-fly Sheeter

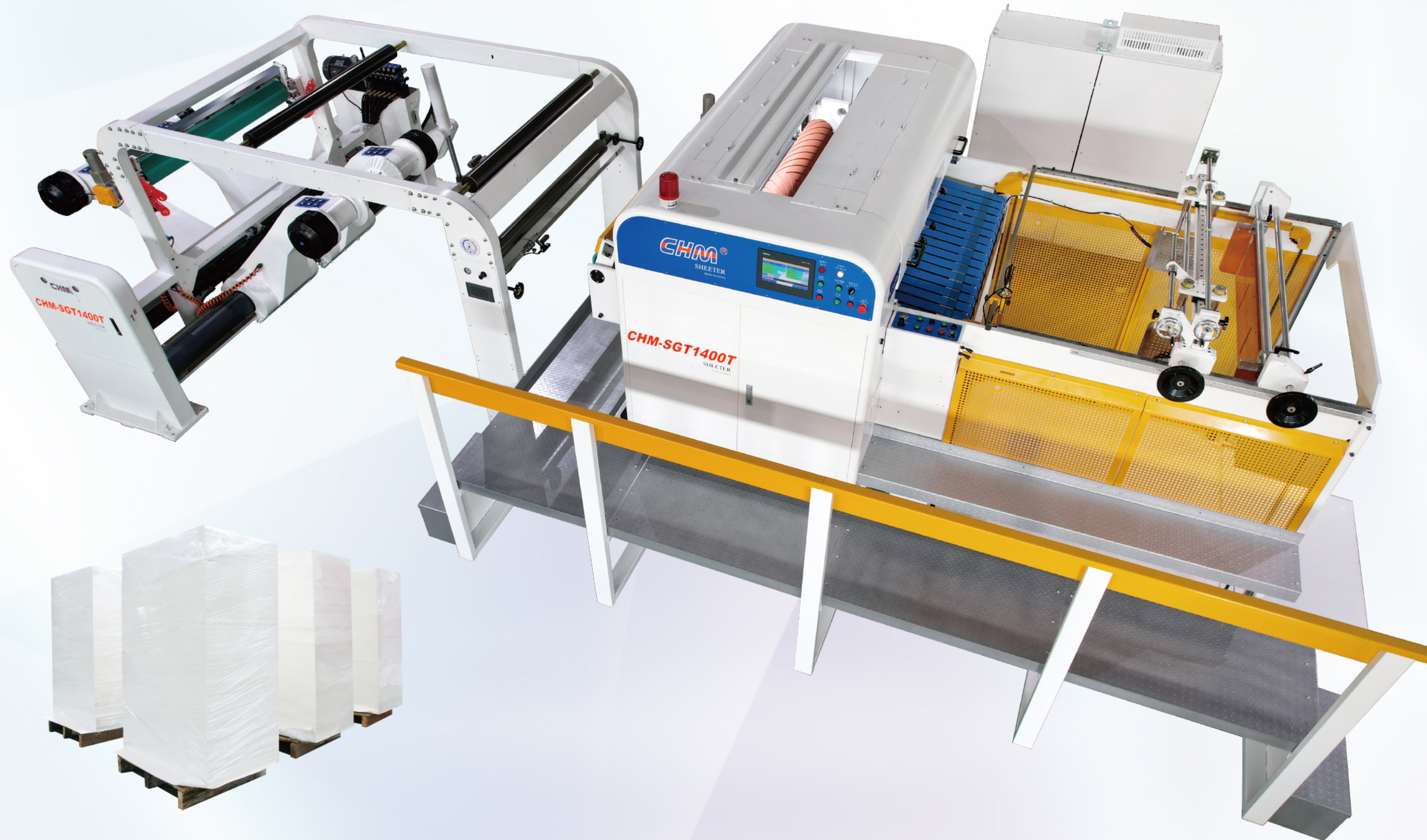

CHM-SGT1400T 高精度双回旋刀卷筒纸分切机是以上下刀对偶螺旋线分切形式剪切,切口干净、整齐、分切精度高等特点,广泛适用于卡纸、铜版纸、牛皮纸、文化纸、双胶纸、高光相纸、金银卡纸、铝箔纸、激光镭射纸、烟酒包装纸等。

CHM-SGT1400T High Precision Synchronize-fly Sheeter features fibre-less and clean cuts with high dimensional precisions. Best for board paper, art paper, kraft paper and packing paper or board etc.



双臂油压无轴原纸架  
Hydraulic shaft-less unwind station



反曲装置  
De-curl unit



自动纠偏  
Automatic correction



电动胶轴反曲  
Electric de-curl unit



高精度双回旋横切刀组  
High precision synchronic-fly cutting unit



自动齐纸集纸设备  
Auto Jogger System

### 技术指标 Technical indicators

CHM型号 CHM Type	CHM-SGT1400T
切纸型式 Cutting way	上下刀回旋切 Upper and lower rotary cutting mechanism
纸张适用范围 Refence weight of cutting paper	200-1000 GSM
切纸精度 Cutting accuracy	±0.5mm
最高切断速度 Max cutting speed	300m/min
最大裁切刀数 Max.number of cutting knives	400cuts/min
切断长度范围 Cutting length range	450-1450mm
最大卷筒纸直径 Max scroll diameter	Max1800mm (71")
收纸台堆纸高度 Stacking height Of paperboard	含托盘1200mm (47") (Include Pallet height)
最大切纸宽度 Max.paper-cutting width	Max1400mm (55")
总重量 Weight	11000kg
尺寸(长*宽*高) Dimension(LxWxH)	10508mm*4320mm*2315mm



## CHM Custom Machine 定制机型

不停机上纸&接纸机  
Auto Splice



CNC自动控制  
CNC automatic control

- 适应国内外所有原纸的克重：80g/m<sup>2</sup>-400g/m<sup>2</sup>
  - 配合原纸架自动张力控制，可高速接纸，成功率高
  - 无纸尾接纸，降低原纸损耗(原纸重叠部分只与胶带同宽约40mm)
  - 全部采用CNC自动控制，动作准确，故障少，维护方便
  - 最高接纸速度：250米/分钟纸速
  - 可选配高速型自动接纸机：300米/分钟纸速
- 
- Suitable for the weight of all domestic and foreign roll papers: 80g/m<sup>2</sup> to 400g/m<sup>2</sup>
  - Combined with automatic tension control of the original paper holder, it can receive paper at high speed and has a high success rate.
  - Paperless tail paper to reduce paper loss (the overlapping part of the paper is only about 40mm wide as the tape).
  - All adopt CNC automatic control, with accurate action, few faults, and convenient maintenance.
  - Maximum paper receiving speed: 250 meters/minute paper speed
  - Optional high-speed automatic paper feeder: 300 meters/minute paper speed

## CHM Custom Machine 定制机型

不停机收纸&不停机换托盘装置  
Auto Pallet Change

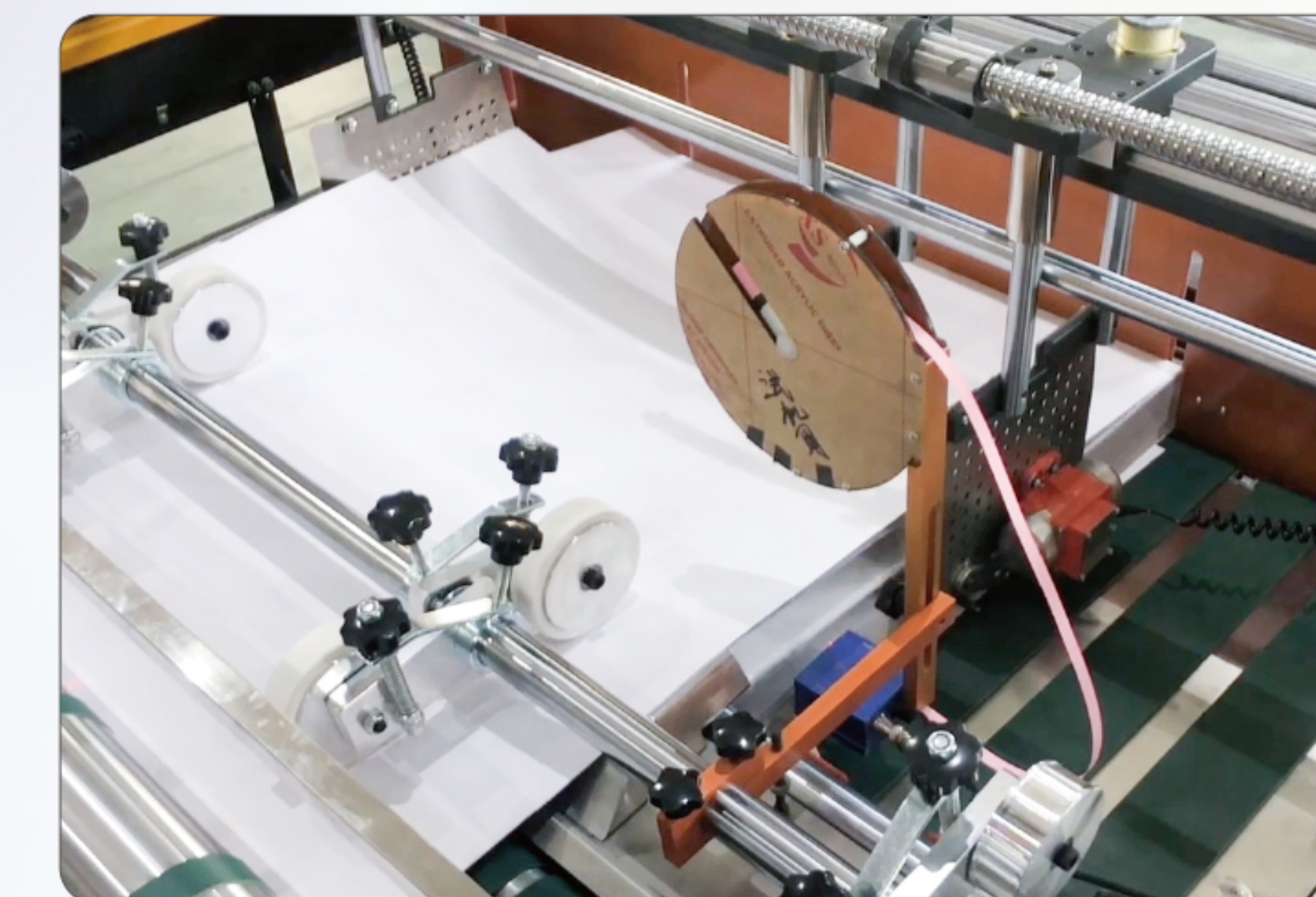

实现不需要停机就可以替换新的托盘，提高生产效率  
No need to change the tray, automatic paper picking. Improving production efficiency.

## CHM-A4-4/5

### A4复印纸双回旋刀切纸机令纸生产线 A4 Cut Size Sheeting And Packaging Production Line



原纸架  
Unwind Stand



导纸设备  
Web guide system

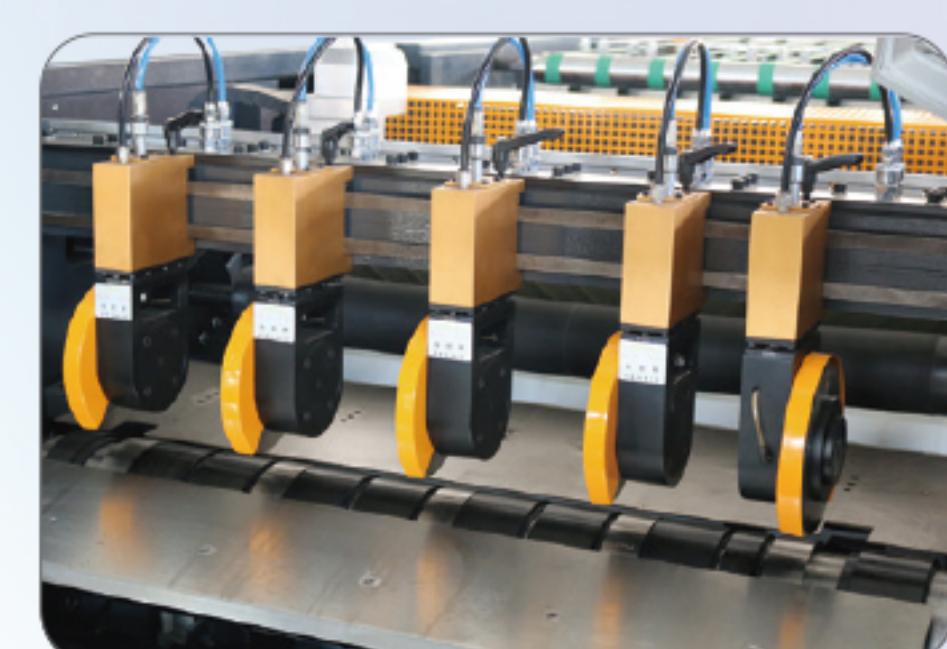

分条刀  
Slitting knife

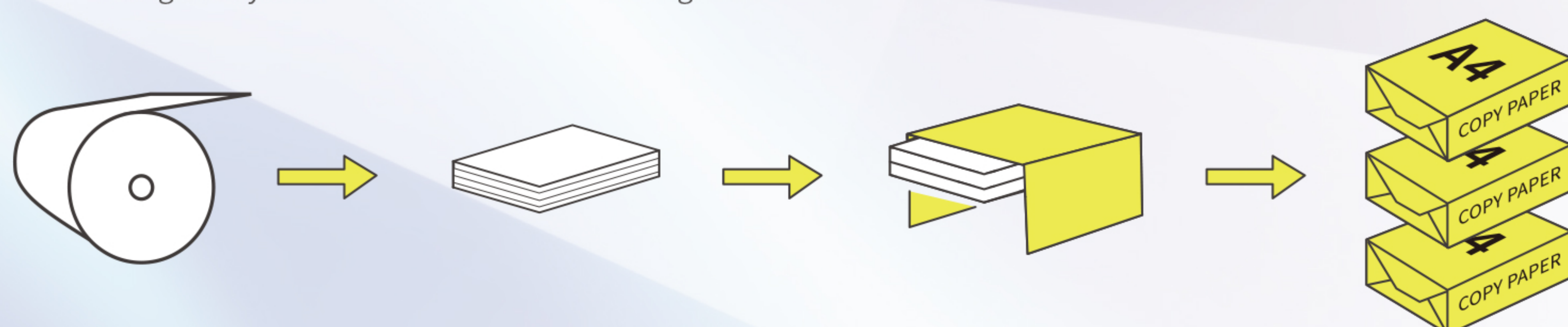

CHM-A4-4/5 A4复印纸双回旋刀切纸机令纸生产线螺旋线刀槽搭配无间隙齿轮, 实现了世界上最先进的双回旋同步剪切切断新工艺, 是集令纸分切、包装、令纸包装箱自动化一体的复印纸加工生产设备。

CHM-A4-4/5. A4 cut size sheeting and packaging production line adopts the most advanced Twin Rotary Knife Synchronize Sheeting technologies. Capable of fully automatic ream and box wrapping.

#### 技术指标 Technical indicators

CHM型号 Cutting Type	CHM-A4-4	CHM-A4-5
纸卷宽度 Paper Width	845-850mm	1055-1060mm
生产运行速度 Production speed	Max280米/分钟 Max280m/min	Max280米/分钟 Max280m/min
切纸精度 Cutting accuracy	±0.2mm	±0.2mm
上纸卷数 Paper Rolls number	4卷/5卷 4 Rolls/5 Rolls	5卷 5 Rolls
分裁数 Pocket	4裁 4 Pocket	5裁 5 Pocket
产量 Output of the ream	Max30令(37令)/每分钟 Max 30(37) Reams/min	Max42令/每分钟 Max 42 Reams/min
整机功率 Power	32kw+18kw+18kw	34kw+18kw+18kw
机器尺寸(长*宽*高) Dimension (LxWxH)	17681mm*4140mm*3190mm *不同卷数以实际平面图为准 Different areas are subject to actual floor plans.	20114mm*4355mm*3190mm

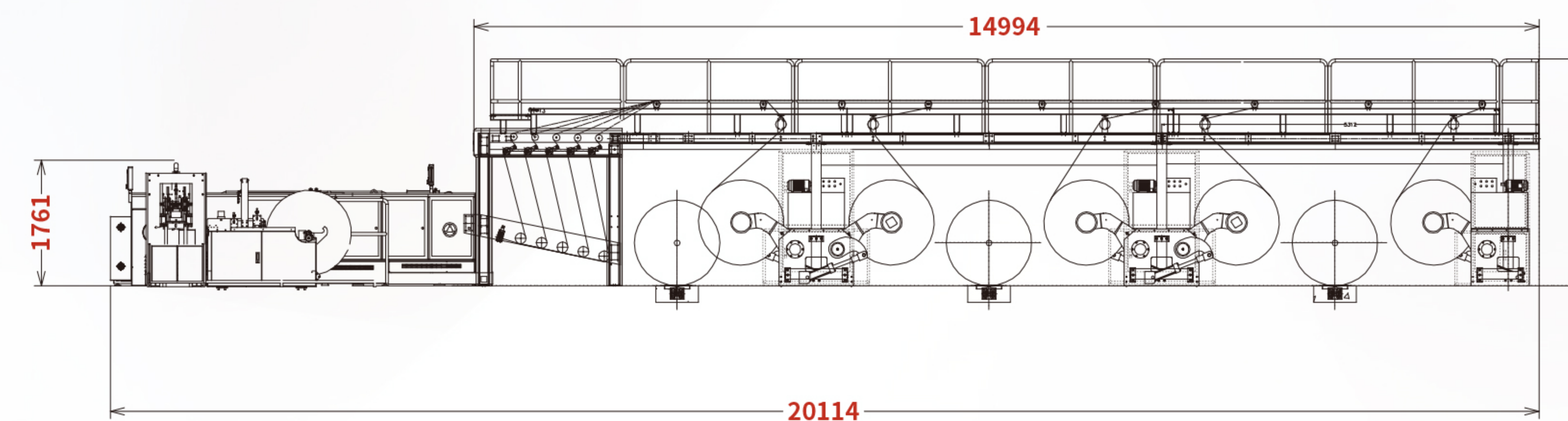

## CHM-A4-2

### A4复印纸双回旋刀切纸机令纸生产线 Compact A4 Cut Size Sheeting And Packaging Production Line

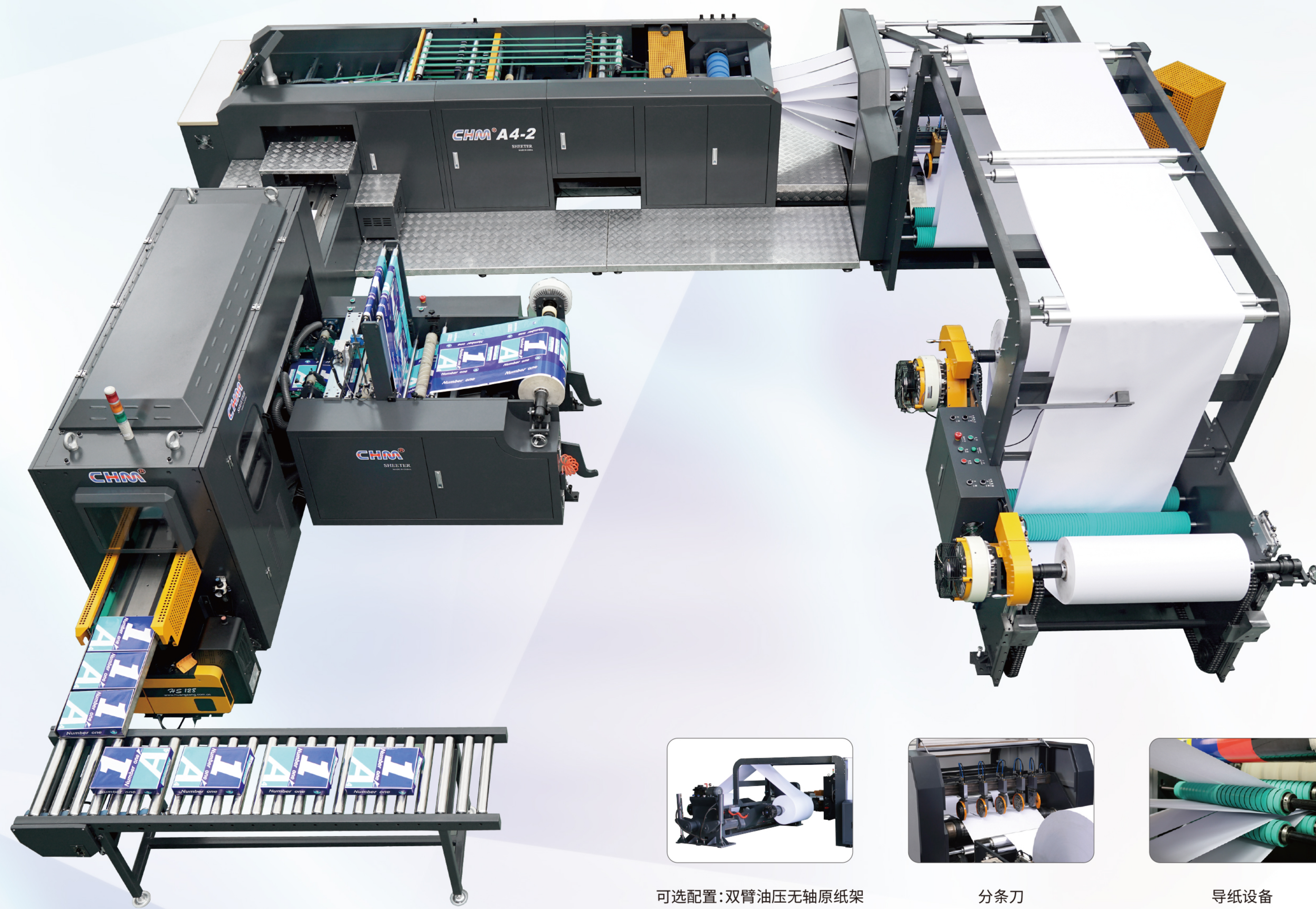

CHM-A4-2 A4复印纸双回旋刀切纸机令纸生产线螺旋线刀槽搭配无间隙齿轮,实现了世界上最先进的双回旋同步剪切的切断新工艺,是集令纸分切、包装、令纸包装箱自动化一体的复印纸加工生产设备。

CHM-A4-2. A compact space saving, high efficiency A4 copy paper sheeting and packaging production line adopts the most advanced Twin Rotary Knife Synchronize Sheeting technologies. Capable of fully automatic ream and box wrapping.

#### 技术指标 Technical indicators

切纸型号 Cutting Type	CHM-A4-2
纸卷宽幅 Paper Width	845-850mm
设计运行速度 Design speed	Max300米/分钟 Max300m/min
切纸精度 Cutting accuracy	±0.2mm
上纸卷数 Paper Rolls number	2卷 2Rolls
分裁数 Pocket	2裁 2Pocket
产量 Output of the ream	Max13令/分钟 Max13Reams/min
整机功率 Power	25kw+18kw
机器尺寸(长*宽*高) Dimension(LxWxH)	7000mm*6600mm*1950mm



可选配置:双臂油压无轴原纸架  
Optional: Hydraulic Shaftless Unwind station

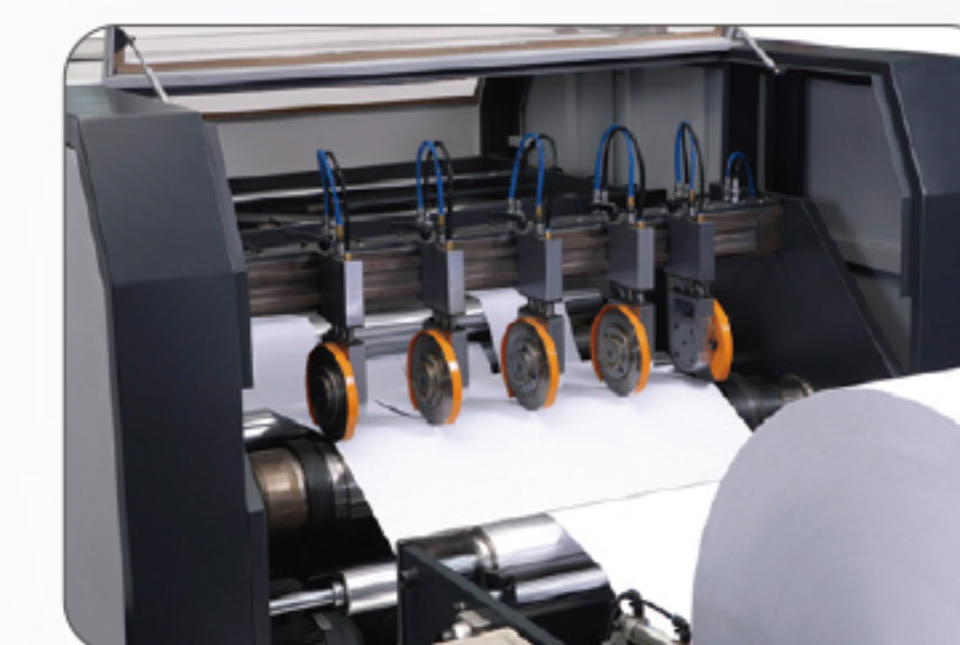

分条刀  
Slitting knife



导纸设备  
Web guide system



电器设备  
Electrical equipment

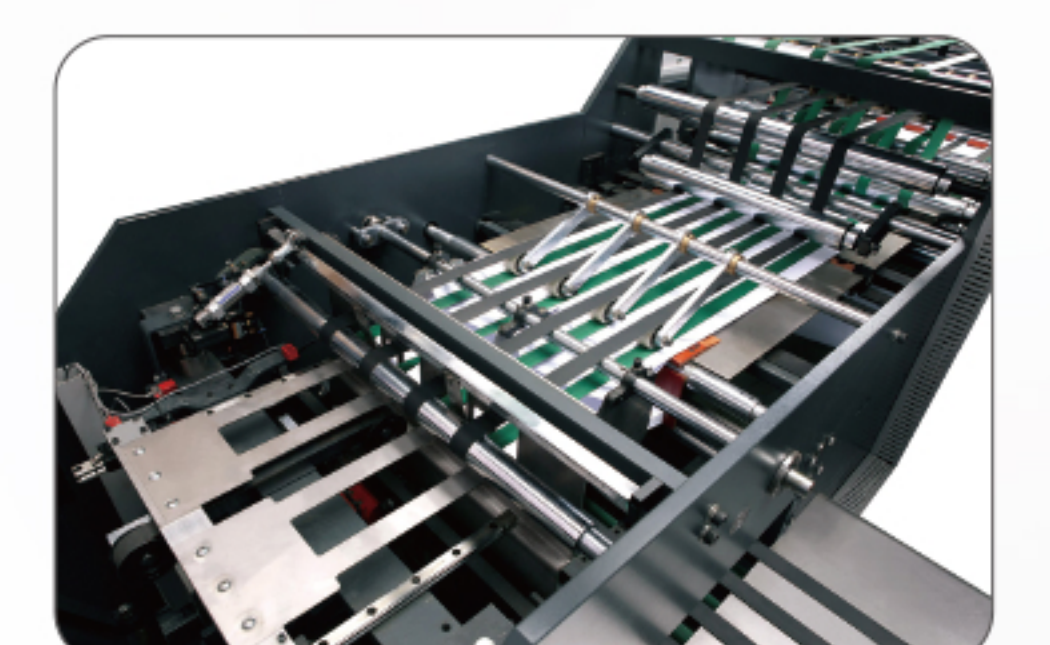

输送部  
Conveyor unit

## CHM-A5-6(pocket)

### A5复印纸双回旋刀切纸机令纸生产线 A5 Cut Size Sheeting And Packaging Production Line



原纸架  
Unwind Stand



导纸设备  
Web guide system

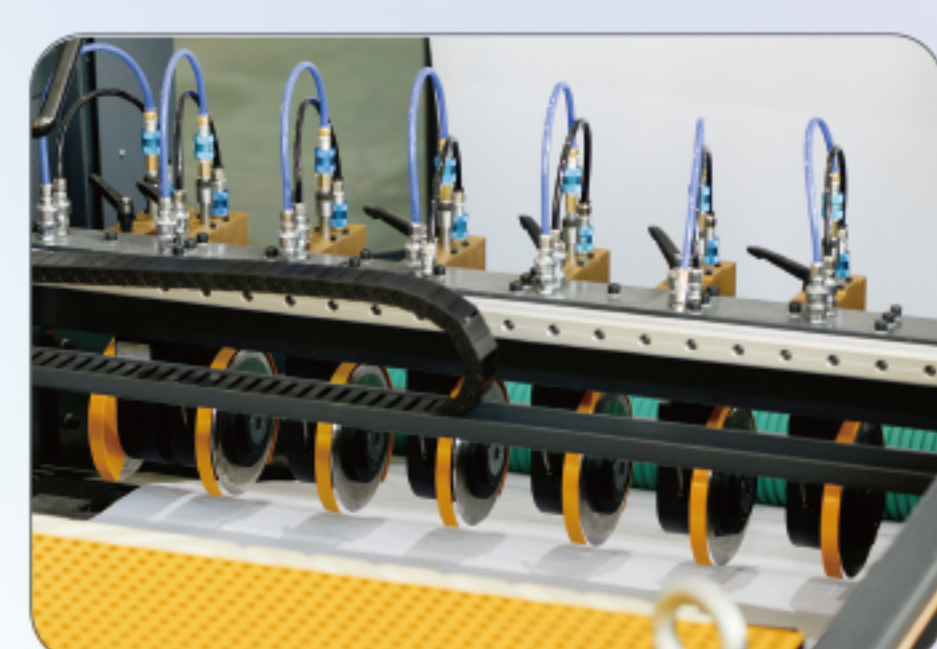

分条刀  
Slitting knife

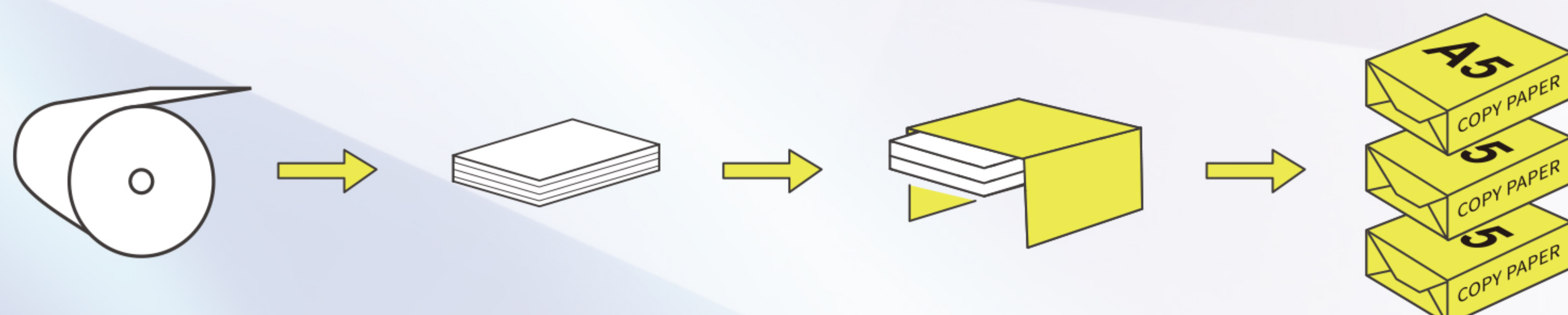

CHM-A5-6 A5复印纸双回旋刀切纸机令纸生产线螺旋线刀槽搭配无间隙齿轮, 实现了世界上最先进的双回旋同步剪切的切断新工艺, 是集令纸分切、包装、令纸包装箱自动化一体的复印纸加工生产设备。

CHM-A5-6. A5 cut size sheeting and packaging production line adopts the most advanced Twin Rotary Knife Synchronize Sheeting technologies. Capable of fully automatic ream and box wrapping.

#### 技术指标 Technical indicators

切纸型号 Cutting Type	CHM-A5-6(pocket)
纸卷宽幅 Paper Width	897-900mm
生产运行速度 Production speed	Max220米/分钟 Max220m/min
切纸精度 Cutting accuracy	±0.2mm
上纸卷数 Paper Rolls number	4卷 4Rolls
分裁数 Pocket	6裁—A5短边148.5mm 6Pocket-A5 short side 148.5mm
产量 Output of the ream	Max50令/分钟 Max 50Reams/min
整机功率 Power	34kw+18kw
机器尺寸(长*宽*高) Dimension(LxWxH)	17681mm*4140mm*3190mm

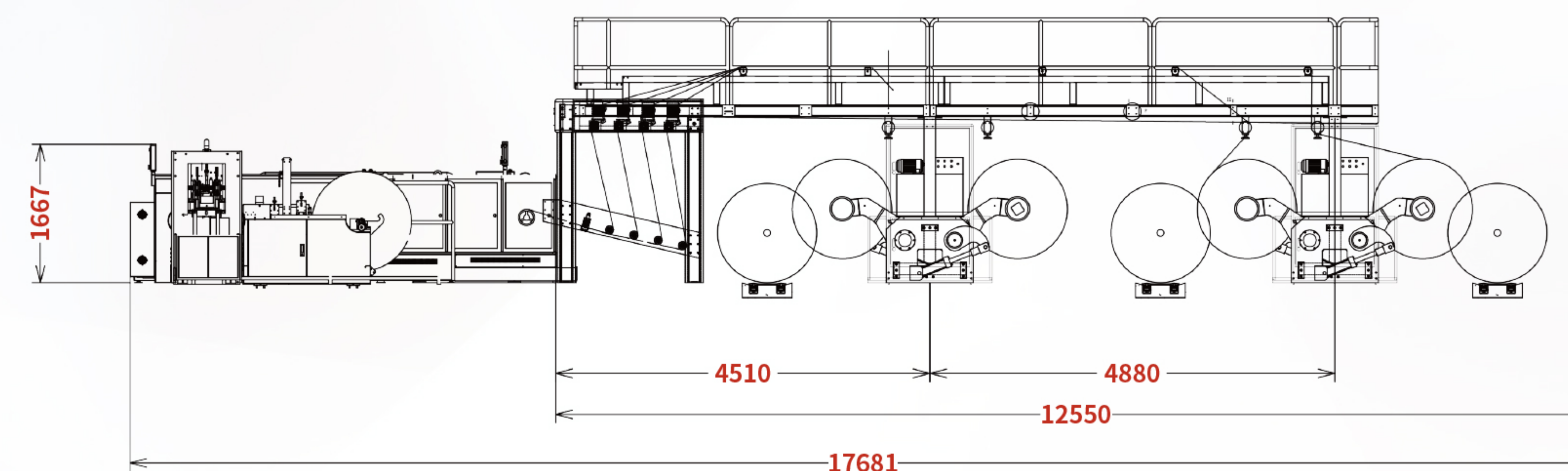

## CHM Custom Machine 定制机型

### 8K复印纸双回旋刀切纸机令纸生产线 8K Cut Size Sheeting And Packaging Production Line

CHM-8K-4 正度8K复印纸双回旋刀切纸机令纸生产线螺旋线刀槽搭配无间隙齿轮, 实现了世界上最先进的双回旋同步剪切的切断新工艺, 是集令纸分切、包装自动化一体的复印纸加工生产设备。

CHM-8K-4. 8K cut size sheeting and packaging production line adopts the most advanced Twin Rotary Knife Synchronize Sheeting technologies. Capable of fully automatic ream wrapping.



原纸架  
Unwind Stand



导纸设备  
Web guide system



分条刀  
Slitting knife

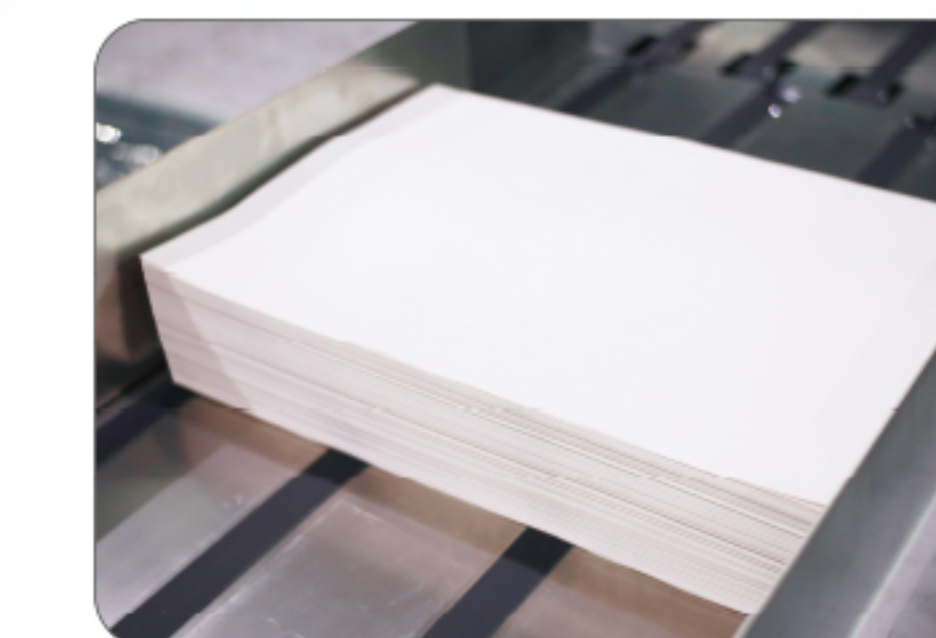
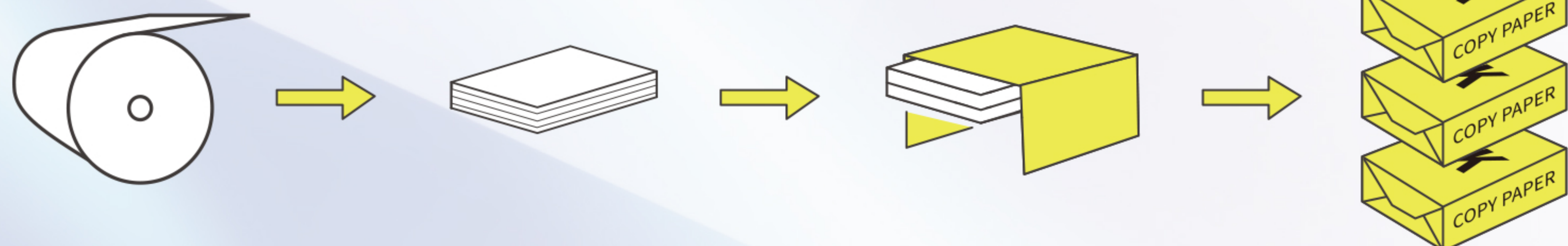

令纸输送  
Ream Output



自动折叠令纸包装  
Automatic Box Loading

## CHM Custom Machine 定制机型

A3、A4同时分切双回旋刀切纸机令纸生产线  
A3&A4 Cut Size Sheeting And Packaging Production Line

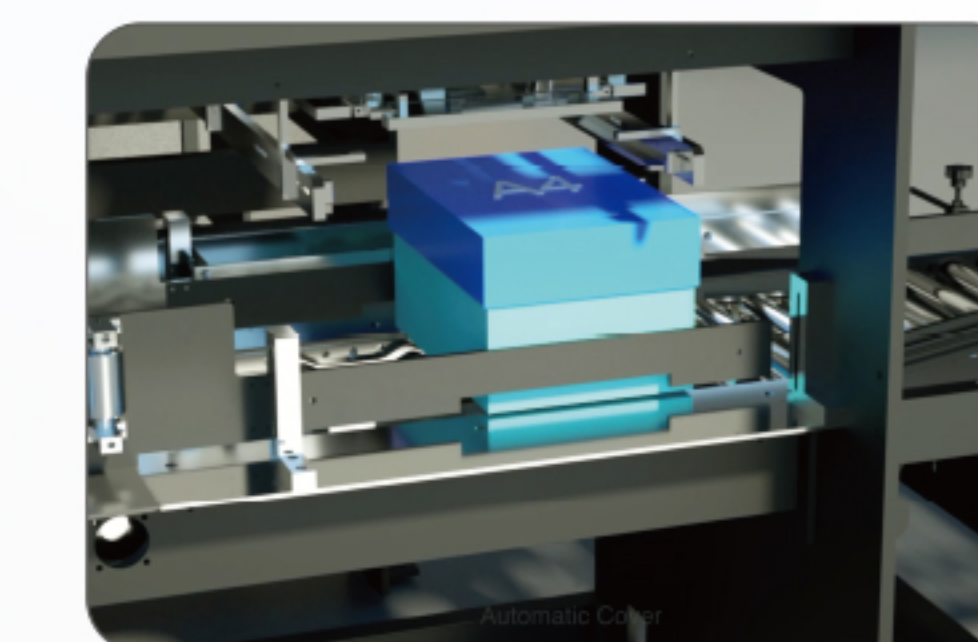
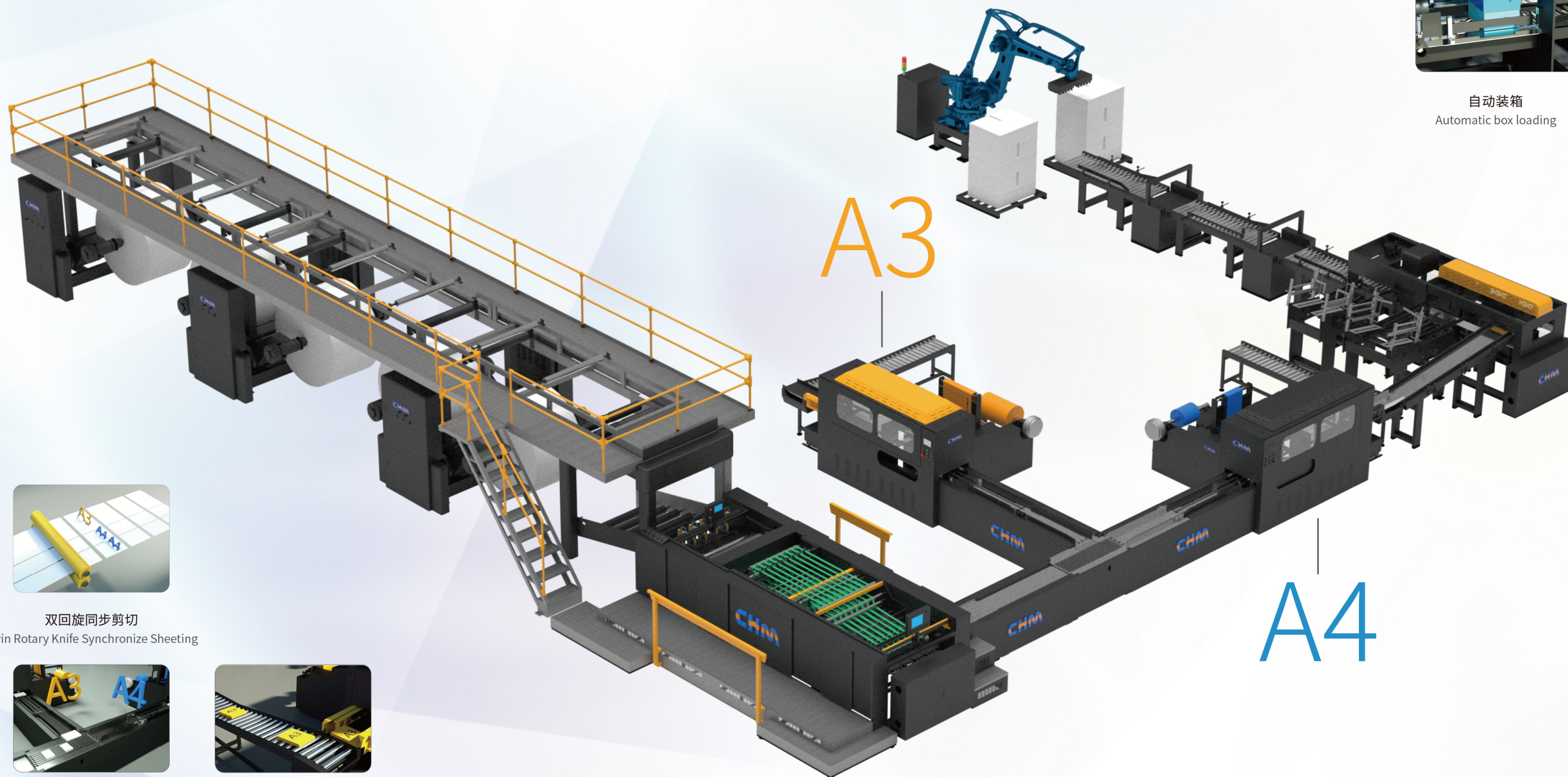

自动装箱  
Automatic box loading

A3

A4

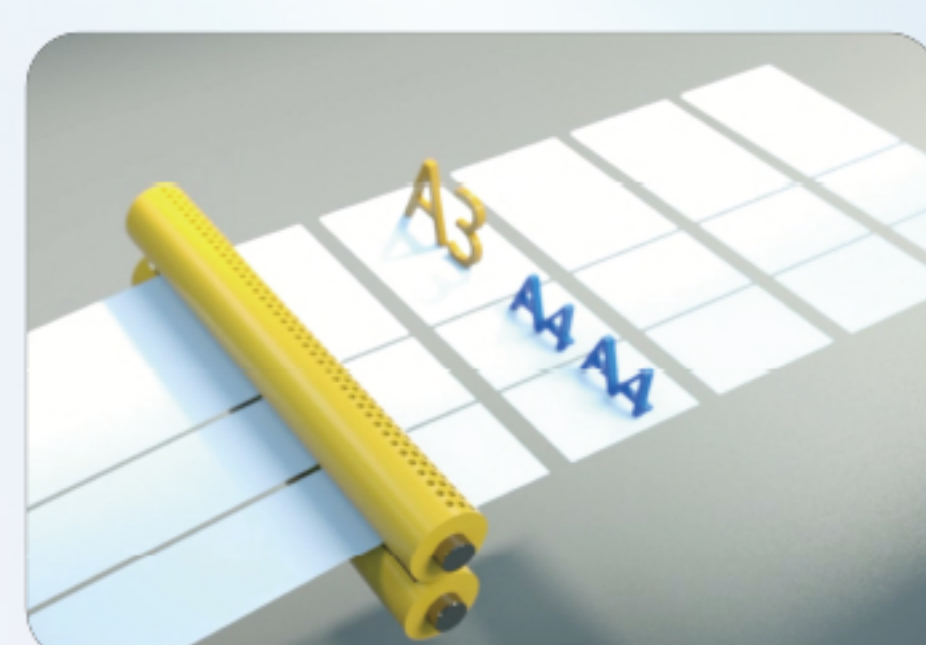

双回旋同步剪切  
Twin Rotary Knife Synchronize Sheeting

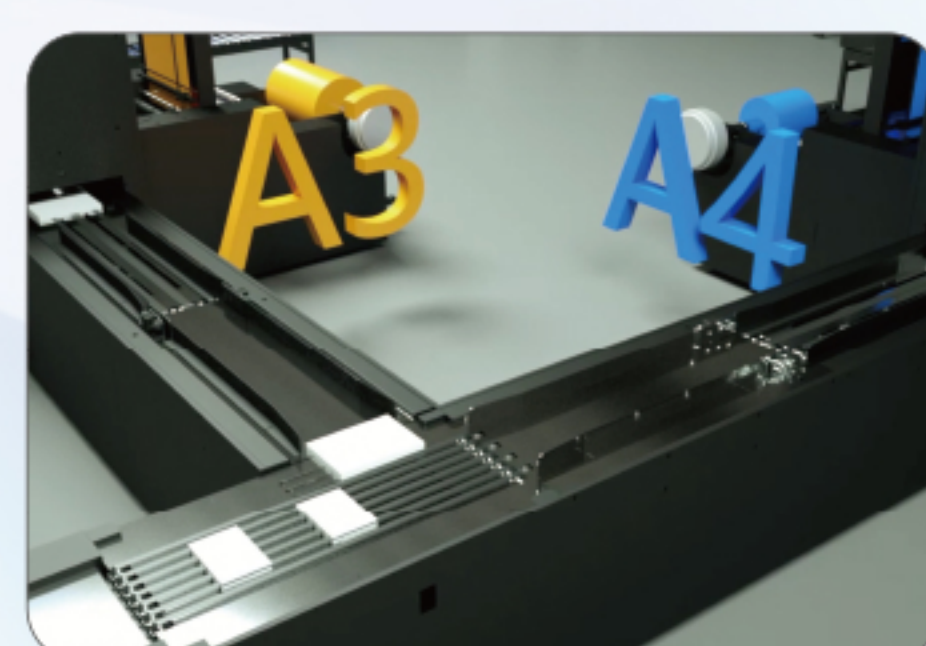

令纸输送  
Ream output

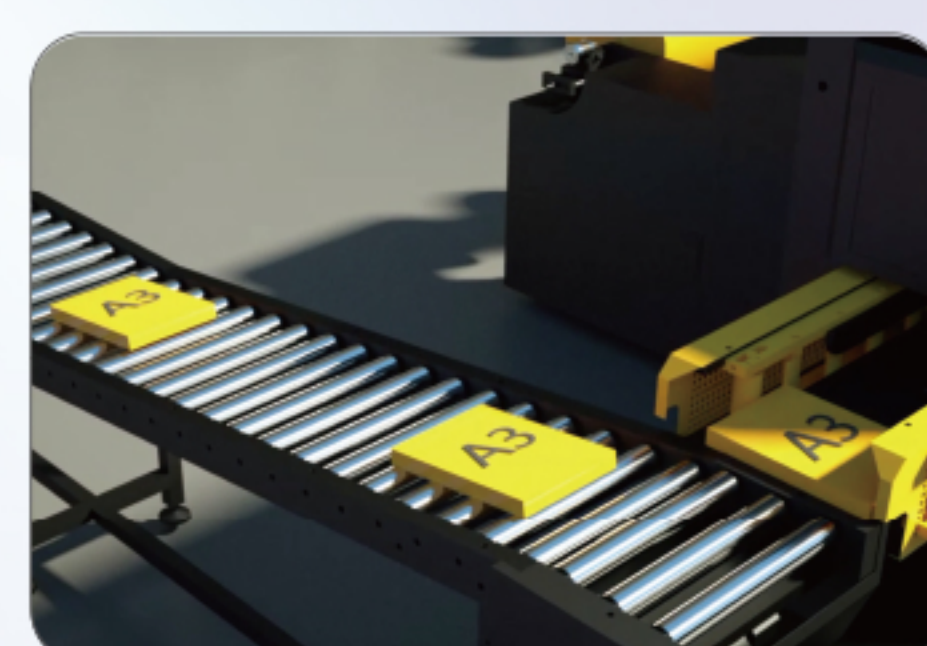

令纸包装  
Paper Packaging

## CHM-A3B

### A3令纸包装生产线设备 A3 Paper Packaging Production Line Equipment



CHM-A3B A3令纸包装生产线设备, 本机是集电气自动化、PLC控制系统和机械自动化为一体的由令纸集备、令纸拉开、令纸记忆输送、令纸包装、令纸集纸排出的连续生产的一整套包装生产线设备。

CHM-A3B. A3 paper packaging production line equipment, this machine is a set of packaging production line equipment, which integrates electrical automation, PLC control system and mechanical automation. It is a complete set of packaging production line equipment for continuous production, which is composed of preparation, opening, memory transmission, packaging and discharging.

#### 技术指标 Technical indicators

包装令纸工作宽度 Packing Paper Width	毛宽(430mm);净宽(420mm) Gross width:430mm ;net width :420mm
包装令纸工作高度 Packing Paper Height	Max 55mm ; Min 45mm
包装纸宽度 Wrapping Paper Width	730mm
包装纸克重范围 Weight range of wrapping paper	70-100g/m2
包装纸等级 Wrapping Paper Grade	铜版纸或双胶纸淋PE膜处理后的包装纸 Coated paper coated with PE film or offset paper coated with PE film.
设计速度 Design Speed	Max 25令/min Max 25 Reams / min
生产速度 Operation Speed	Max 18令/min Max 18 reams/min
压缩空气消耗 Compressing Air Consumption	(approm)250NL/min
整机功率 Power	(approm)18KW
机器尺寸(长宽x高) Dimension(LxWxH)	7676mm*3026mm*1729mm

## CHM-A4B

### A4令纸包装生产线设备 A4 Paper Packaging Production Line Equipment



CHM-A4B A4令纸包装生产线设备, 本机是集电气自动化、PLC控制系统和机械自动化为一体的由令纸集备、令纸拉开、令纸记忆输送、令纸包装、令纸集纸排出的连续生产的一整套包装生产线设备。

CHM-A4B. A4 paper packaging production line equipment, this machine is a set of packaging production line equipment, which integrates electrical automation, PLC control system and mechanical automation. It is a complete set of packaging production line equipment for continuous production, which is composed of preparation, opening, memory transmission, packaging and discharging.

#### 技术指标 Technical indicators

包装令纸工作宽度 Packing Paper Width	毛宽(310mm);净宽(297mm) Gross width:310mm ;net width :297mm
包装令纸工作高度 Packing Paper Height	Max 55mm ; Min 45mm (小于55mm或大于45mm, 可根据用户要求)
卷纸直径 Packing Roll Dia	Max.1000 mm ; Min.200mm
包装纸宽度 Wrapping Paper Width	560mm
包装纸克重范围 Weight range of wrapping paper	70-100g/m2
包装纸等级 Wrapping Paper Grade	铜版纸或双胶纸淋PE膜处理后的包装纸 Coated paper coated with PE film or offset paper coated with PE film.
设计速度 Design Speed	Max 40令/min Max 40 Reams / min
生产速度 Operation Speed	Max 35令/min Max 35 Reams / min
压缩空气消耗 Compressing air consumption	(approm) 300NL/mint
整机功率 Power	(approm) 18KW

## CHM-A4DB

### A4复印纸令包箱生产线设备 Ream Paper Box Wrapping Machine

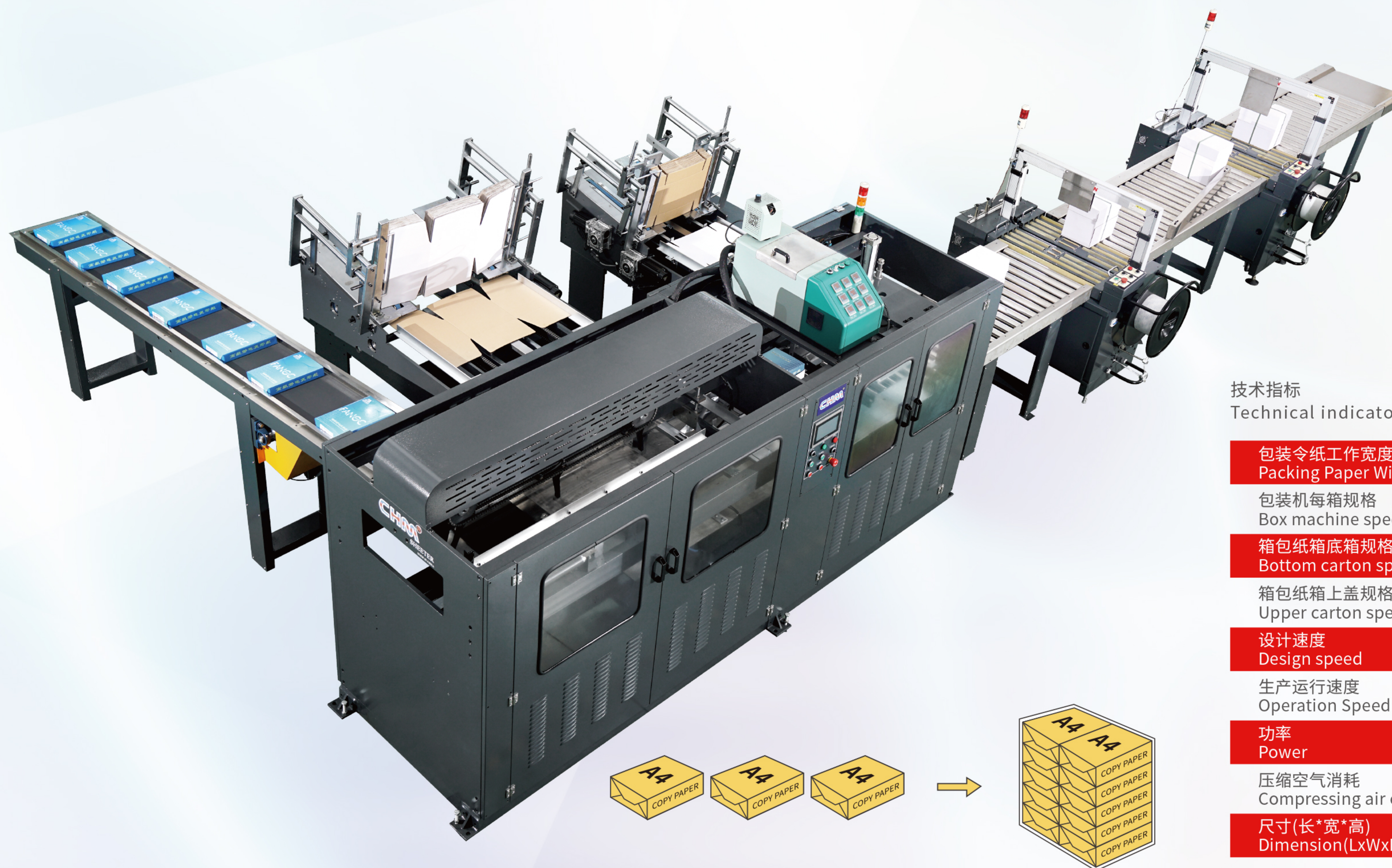

本机集电器自动化、PLC控制系统和机械自动化为一体的由令纸输送、令纸收集、令纸计数收集、自动装箱、自动输送、自动上盖、打包成箱。

Integrates the highly advanced electronics automation, PLC control system and mechanical automation. All-in-one paper conveying, ream paper collection, ream paper counting and collection, automatic loading, automatic covering, into packed boxes.

#### 技术指标 Technical indicators

包装令纸工作宽度 Packing Paper Width	毛宽(310mm); 净宽(297mm) Gross width: 310mm; net width: 297mm	
包装机每箱规格 Box machine specification	5包/箱 5 packages/box	10包/箱 10 packages/box
箱包纸箱底箱规格 Bottom carton specification	803mm*529mm	803mm*739mm
箱包纸箱上盖规格 Upper carton specification	472mm*385mm	472mm*595mm
设计速度 Design speed	Max5-10箱/分钟 Max 5-10 boxes/min	
生产运行速度 Operation Speed	Max7箱/分钟 Max 7 boxes/min	
功率 Power	(approm)18KW	
压缩空气消耗 Compressing air consumption	(approm)300NL/min	
尺寸(长*宽*高) Dimension(LxWxH)	10263mm*5740mm*2088mm	

#### 全自动一体化完成 Auto-production line



## CHM-PE-A4DB

### 全自动薄膜封箱机

### Fully Automatic Film Sealing Machine

CHM-PE-A4DB 全自动薄膜封箱机是由封切机和热收缩包装机共同组成，以热收缩薄膜为材料。在令纸裹膜后(切断和封口)进入热收缩包装机完成包装。整机结构紧凑占地面积小，采用先进光电，准确定位。令纸经过该包装机的包装后，具有外形美观、整洁、防尘、防潮、防破损便于搬运和储存。相比传统的纸箱包装可大大降低产品损耗且具有包装成本优势。

The CHM-PE-A4DB fully automatic film sealing machine is composed of a sealing and cutting machine and a heat shrink packaging machine, using heat shrink film as the material. After wrapping the copy paper with film (cutting and sealing), it enters the heat shrink packaging machine to complete the packaging. The whole machine has a compact structure and a small footprint, using advanced optoelectronics for accurate positioning. After being packaged by the packaging machine, the copy paper has a beautiful, clean, dustproof, moisture-proof, and damage resistant appearance, making it easy to handle and store. Compared to traditional cardboard packaging, it can greatly reduce product loss and has packaging cost advantages.



封膜成品  
Sealing film finished product



防尘、防潮  
Dust and moisture prevention

# BRTIRUS2550A

## 六轴工业码垛机器人 Six-axis Stacking Machine

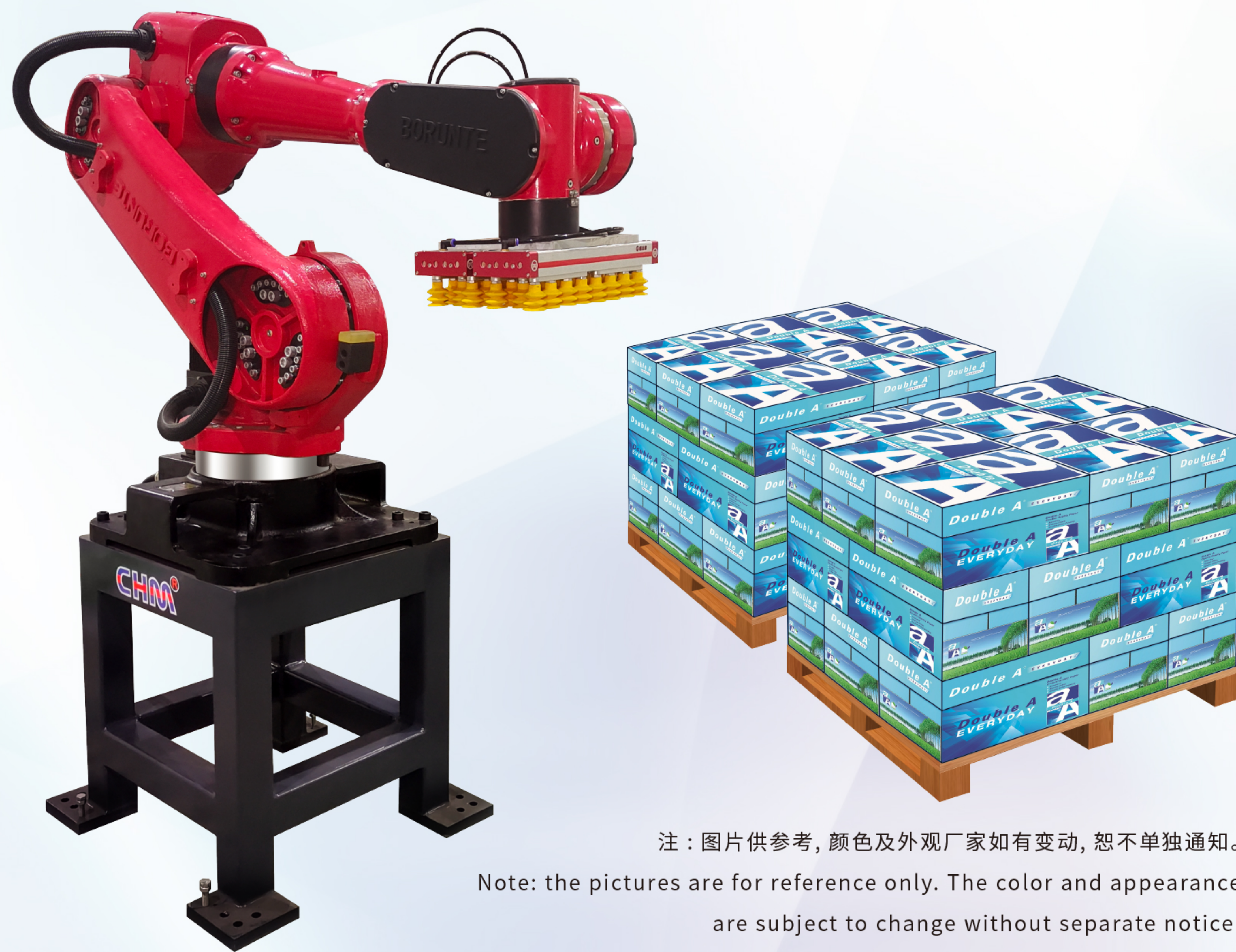

注：图片供参考，颜色及外观厂家如有变动，恕不单独通知。  
Note: the pictures are for reference only. The color and appearance are subject to change without separate notice.

BRTIRUS2550A是针对多自由度的复杂应用而开发的一款六轴工业机器人，其拥有2550mm超长臂展，最大负载可达50kg。具有六个自由度的灵活性，对上下料、装配、注塑等场景能够应对自如。

- 防护等级高—IP54，防尘防水。
- 精度高—重复定位精度±0.1mm。

BRTIRUS2550A type robot is a six axis robot that developed for some monotonous, frequent and repetitive long-term operations or operations in dangerous and harsh environments. The maximum arm length is 2550mm. The maximum load is 50KG. It has six degrees of flexibility. Suitable for loading and unloading, assembling, molding, stacking etc.

- The protection grade reaches IP54. Water and dust resistant.
- The repeat positioning accuracy is ±0.1mm.

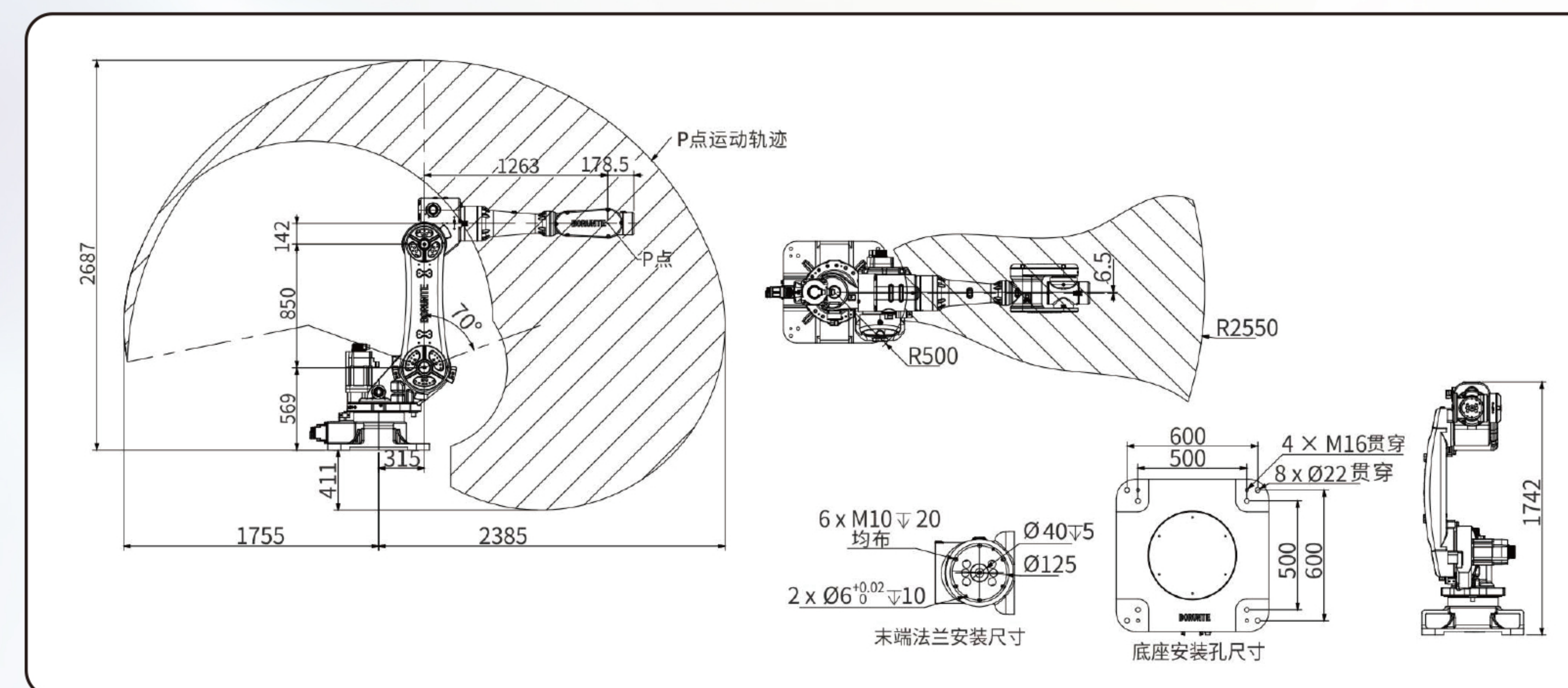

### 技术指标 Technical indicators

产品型号 Model	项目 Item	手臂 Arm			手腕 Wrist			臂展 Arm Length	负载 Loading ability	重复定位精度 Repeatability	电源容量 Power Source	本体重量 Net Weight
		J1	J2	J3	J4	J5	J6					
BRTIRUS2550A	臂展 Arm Length(mm)	地面-2轴距 569mm		2-3轴距 850mm		3-5轴距 1263mm	5轴-端面距 178.5mm	2550mm	50KG	±0.1mm	16.7KVA	约725KG
	范围 Range(#°)	±160°	±70°	-75°/+115°	±180°	±125°	±360°					
	最大速度 Max. Speed(#°/S)	84°/S	52°/S	52°/S	245°/S	223°/S	223°/S					

## HANDLING FORKLIFT

### 1.5吨原纸纸卷全电动搬运车

### 1.5 Tons Base Paper Roll All-Electric Handling Forklift



智能工学手柄  
Intelligent Handle



实时数字液晶屏&急停开关  
LCD&Emergency Stop Button



大功率有刷电机  
High-Power Brush Motor



内置式充电器  
Built-in Charger

- 适用于造纸行业，包装印刷业，纺织行业搬运纸筒、地毯、布料等圆柱形货物。
- 根据人机工程学原理设计的舵柄，操作简单、安全、灵活。

• It is suitable for the paper industry, packaging and printing industry, and the textile industry to handle cylindrical goods such as paper tubes, carpets, and fabrics.

• The tiller designed according to ergonomic principles is simple, safe, and flexible to operate.

#### 技术指标 Technical indicators

动力形式 Power Mode	电动 Motor-Driven
操作类型 Operation Type	步行式 Walking Style
载荷能力 Load Capacity	1500 KG / 2000 KG / 3000 KG (支持定制 Customization)
电池容量 Battery Capacity	24V 65A
满电工况连续使用时长 Continuous Use At Full Power	约4-6小时 About 4-6 Hours
货叉长 Fork Length	1220mm
适合纸卷直径 Suitable For Roll Diameter	800-1300mm



助力纸企提高生产效率  
Assist paper companies provide capacity.

## 售后服务 After-sale service

我们的服务宗旨：“及时、准确、满意”，在收到服务信息后及时主动作出答复或派技术人员处理售后服务范围内的任何问题，同时会在现场对用户相关人员进行机器安装调试，现场试验，维护运行等知识培训，使机器最终能安全可靠的投入运营。

Our service tenet: "On Time, accurate, satisfactory", promptly responds after receiving the service information, or send technician to solve any problems within the scope of after-sales service. At the same time, we will install and adjust the machine, make it running in the customer's plant. The operator will be taught how to handle maintenance job and other know-how skills, all this is to make sure the machine could work properly.



## 合作伙伴 Cooperative partner



### ■ 造纸厂 Paper mill

山东太阳、山东华泰、山东天和、山东博汇、山东博闻、河南仙鹤、河南江河、河南双汇、晨鸣纸业、岳阳纸业、珠海红塔仁恒、正隆、东莞建晖、肇庆中盛、高明鸿源、广西贵糖、锦州金城、眉山丰华、四川永丰、江西华劲、黑龙江恒丰、天邦、金蔡伦、亚太纸业.....

### ■ 印刷包装 Printing and packaging

力嘉、美盈森、禧图、中华商务、利丰雅高、贤俊龙、源发、博罗汇星、裕同、正元、中山达跃、江门兴艺、山东鲁信天一、祥恒、联盛、大胜达、凯成、当纳利、九星、盛通、中科、嘉华、北方嘉科、盛大包装.....

### ■ 纸经销商 Paper dealers

荣兴、世纪弘博、全方圆、启润、黄金叶、华发、悦声、纸立方、崇泰、大伦、勤信、全达、五洲、精诚、金汇洋、汇鸿集团.....  
(以上仅为部分合作伙伴,排名不分先后)

